

STOCKHOLM 1 DOOR WARDROBE ASSEMBLY INSTRUCTIONS

Thank you for purchasing the STOCKHOLM 1 DOOR WARDROBE . Please read the instructions carefully to ensure safe operation of the product.

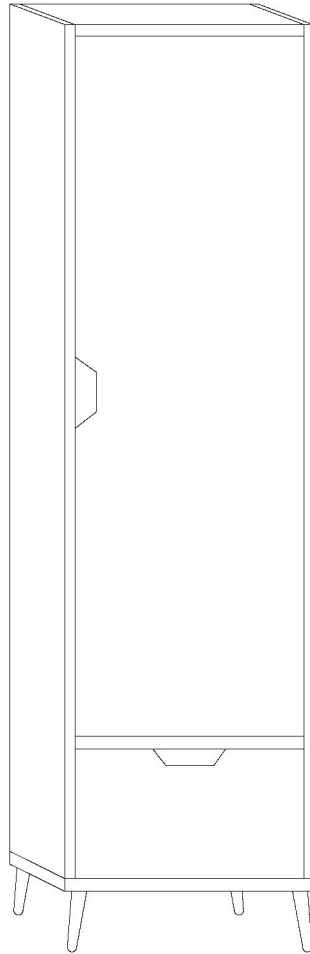

Size: W550xD530xH1705cm
COLOUR: WHITE & OAK

PLEASE READ this sheet prior to assembly to familiarise yourself with the various stages of construction.

Carefully open the pack supplied and check the contents against the parts and fittings check list. Do not destroy any of the packaging until you are certain that you have all the necessary parts for the assembly.

CAUTION: There are small components used in the construction of this unit. These loose items should be kept away from young children whilst assembling your unit to avoid the danger of choking hazards.

Tools Required

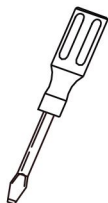
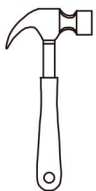

2 Person Build



1 Hour
Set Up

STOCKHOLM 1 DOOR WARDROBE ASSEMBLY INSTRUCTIONS

**IMPORTANT - READ CAREFULLY - RETAIN THESE INSTRUCTIONS
FOR FUTURE REFERENCE.**

INFORMATION

- This product is intended for a maximum load of 20 kg spread evenly through the storage compartments. Do not exceed this weight.
- Due to the size of this product we recommend that it is assembled in the room intended for use.
- When you are ready to start, make sure that you have the right tools, plenty of space and a clean, dry area for assembly.
- Unwrap all packaging materials and place the components on top of the carton box or on a clean floor to prevent it from scratching.
- Check the pack and make sure you have all the parts listed.
- Ensure that this product is fully assembled as illustrated before use.
- Check all screws or bolts are tightened and inspect regularly.
- This product should only be used on firm, level ground.
- Tools are not included.

WARNINGS

- DO make sure the legs remain in contact with the ground.
- DO keep small parts out of reach of children.
- DO NOT use power tools to construct this product.
- DO NOT tighten screws until fully assembled.
- DO NOT over tighten screws or bolts.
- DO NOT use this product if parts are missing, damaged or worn.
- DO NOT sit or stand on the product.
- It is essential that this unit is fixed to a wall with the fixings provided.
- We recommend the use of the wall fixing provided for safety reasons. N.B. if in doubt pls consult a qualified tradesperson. **Warning:** Always ensure the area to be drilled is free from hidden electrical wires, water and gas pipes.

CARE INFORMATION

- Never use scourers, abrasives or chemical cleaners.
- To clean wipe with a sponge and warm soapy water. Do not use solvent based cleaners or detergents as they can bleach or damage the product



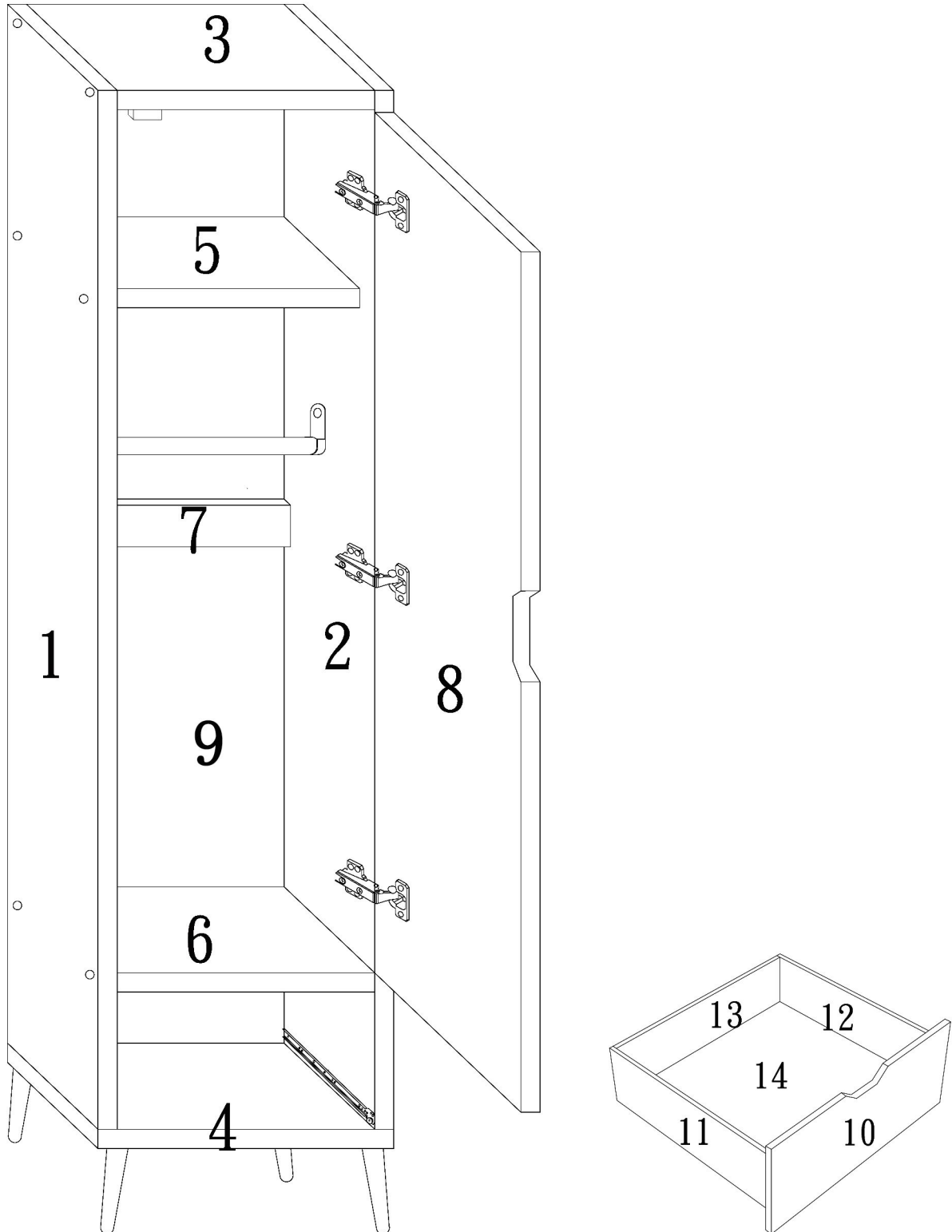

STOCKHOLM 1 DOOR WARDROBE ASSEMBLY INSTRUCTIONS

Please check the pack contents before assembling this product. If any components are missing, please contact your retailer. The fittings pack contains small items that should be kept away from small children.

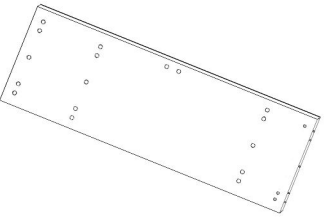
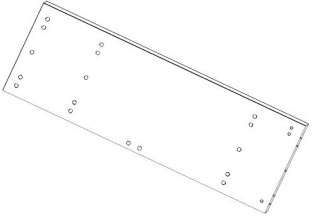
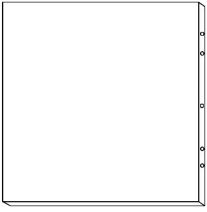
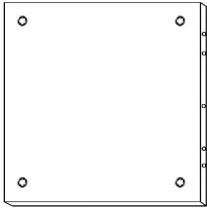
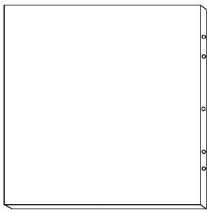
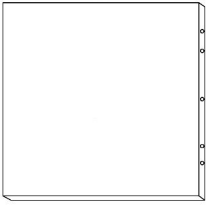

STOCKHOLM 1 DOOR WARDROBE ASSEMBLY INSTRUCTIONS

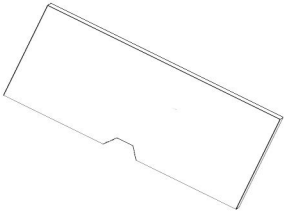
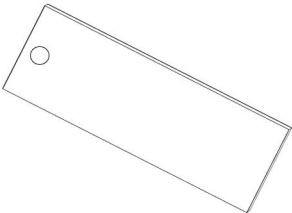
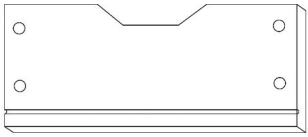
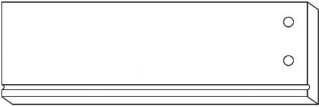
PARTS

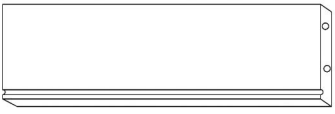
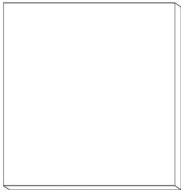
<p>1</p> 	<p>2</p> 	<p>3</p> 
<p>DESCRIPTION: LEFT SIDE PANEL QTY:1 PC DIMENSION: 530X1585X15MM</p>	<p>DESCRIPTION: RIGHT SIDE PANEL QTY:1 PC DIMENSION: 530X1585X15MM</p>	<p>DESCRIPTION: TOP PANEL QTY:1 PC DIMENSION: 529X520X15MM</p>
<p>4</p> 	<p>5</p> 	<p>6</p> 
<p>DESCRIPTION: BOTTOM PANEL QTY:1 PC DIMENSION: 529X550X15MM</p>	<p>DESCRIPTION: UP SHELF PANEL QTY:1 PC DIMENSION: 520X507X15MM</p>	<p>DESCRIPTION: MIDDLE SHELF PANEL QTY:1 PC DIMENSION: 529X520X15MM</p>
<p>7</p> 	<p>8</p> 	<p>9</p> 
<p>DESCRIPTION: SUPPORT PANEL QTY:1 PC DIMENSION: 100X520X15MM</p>	<p>DESCRIPTION: DOOR PANEL QTY:1 PC DIMENSION: 516X1330X15MM</p>	<p>DESCRIPTION: BACK PANEL QTY:1 PC DIMENSION: 540X1588X3MM</p>
<p>10</p> 	<p>11</p> 	<p>12</p> 
<p>DESCRIPTION: DRAWER FRONT PANEL QTY:1 PC DIMENSION: 216X516X15MM</p>	<p>DESCRIPTION: DRAWER LEFT SIDE PANEL QTY:1 PC DIMENSION: 140X452X15MM</p>	<p>DESCRIPTION: DRAWER RIGHT SIDE PANEL QTY:1 PC DIMENSION: 140X452X15MM</p>
<p>13</p> 	<p>14</p> 	
<p>DESCRIPTION: DRAWER BACK SIDE PANEL QTY:1 PC DIMENSION: 140X470X15MM</p>	<p>DESCRIPTION: DRAWER BOTTOM PANEL QTY:1 PC DIMENSION: 480X450X3MM</p>	

STOCKHOLM 1 DOOR WARDROBE ASSEMBLY INSTRUCTIONS

FIXINGS (TO SCALE)

Ref	Dimensions	Qty
A	CAM BOLT (100X35X25MM)	8
B	CAM LOCK (100X35X25MM)	8
C	WOODEN (8x30MM)	22
D	SCREWS (4x35MM)	22
E	SCREWS (4x12MM)	23
F	SCREWS (3.5x12MM)	32

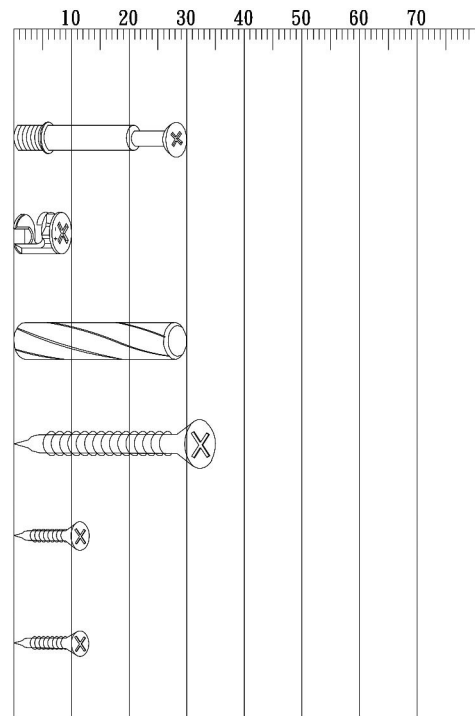

NOT TO SCALE

G	STICKERS	12
H	BAR	1
I	FLANGE	2
J	WALL FIXING HARDWARE	1
K	HINGE	3
L	DRAWER BASE RUNNER SETS(L+R)	1
M	NAIL	30
N	LEG (100X35X25MM)	4
O	LEG BRACKETS	4
P	CABINET RUNNER SETS(L+R)	1
Q	DOOR STOPPER	1

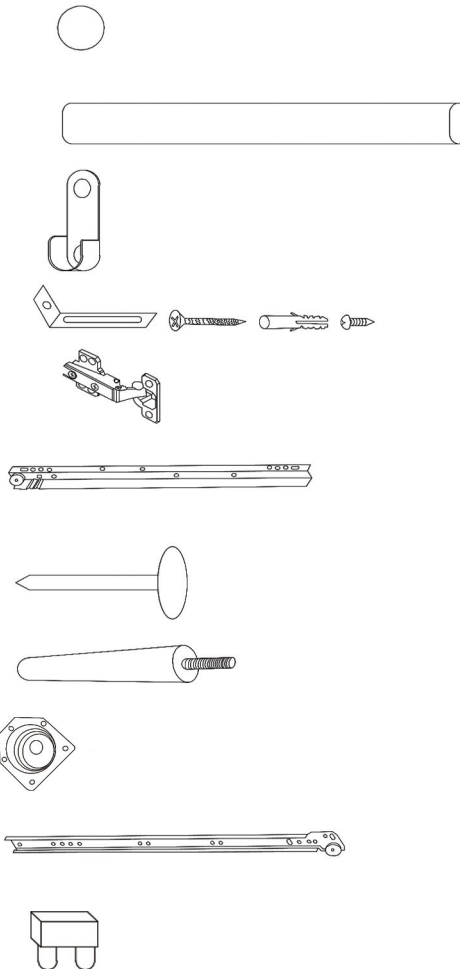

CAUTION: There are many small components used in the construction of this product. Please keep these components away from young children whilst assembling this product. If you keep the fittings in a bowl during assembly you will be less likely to lose them!

STOCKHOLM 1 DOOR WARDROBE ASSEMBLY INSTRUCTIONS

Layout Parts on Soft Surface

Layout all part on a soft surface i.e. Rug,carpet or packaging carton

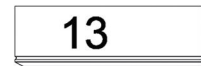
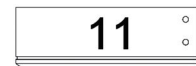
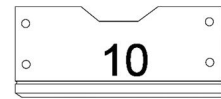
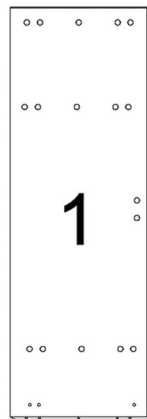
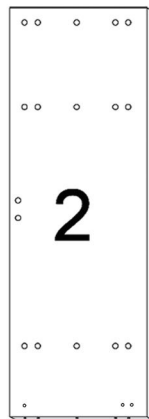

STOCKHOLM 1 DOOR WARDROBE ASSEMBLY INSTRUCTIONS

STEP 1	PARTS REQUIRED
<p>The diagram illustrates the first step of assembly. It shows three main components: 1. Left Side Panel, 2. Right Side Panel, and 3. Top Panel. The side panels are being mounted to a wall using wall fixing hardware (J) and screws (F). The top panel is then attached to the side panels using cabinet runner sets (P) and door stoppers (Q). A hammer is shown being used to secure the door stopper (Q).</p>	<p>1:LEFT SIDE PANEL X1 2:RIGHT SIDE PANEL X1 3:TOP PANEL X1</p> <p>F:SCREWS X6 J:WALL FIXING HARDWARE X1 P:CABINET RUNNER SETS(L+R) X1 Q:DOOR STOPPER X1</p>

STEP 2	PARTS REQUIRED
<p>The diagram illustrates the second step of assembly. It shows the installation of shelves and support panels. Part 3 (Top Panel), Part 5 (Up Shelf Panel), Part 6 (Middle Shelf Panel), and Part 7 (Support Panel) are shown being attached to the side panels (1) using cam bolts (A), cam locks (B), and dowels (C). Screws (D) are used to secure the side panels to the wall.</p>	<p>1:LEFT SIDE PANEL X1 3:TOP PANEL X1 5:UP SHELF PANEL X1 6:MIDDLE SHELF PANEL X1 7:SUPPORT PANEL X1</p> <p>A:CAM BOLT X2 B:CAM LOCK X2 C:DOWEL X9 D:SCREWS X6</p>

STOCKHOLM 1 DOOR WARDROBE

ASSEMBLY INSTRUCTIONS

STEP 3	PARTS REQUIRED
	<p>2:RIGHT SIDE PANEL X1</p> <p>A:CAM BOLT X2 B:CAM LOCK X2 C:DOWEL X9 D:SCREWS X6</p>

STEP 4	PARTS REQUIRED
	<p>4:BOTTOM PANEL X1</p> <p>C:DOWEL X4 D:SCREWS X6</p>

STOCKHOLM 1 DOOR WARDROBE

ASSEMBLY INSTRUCTIONS

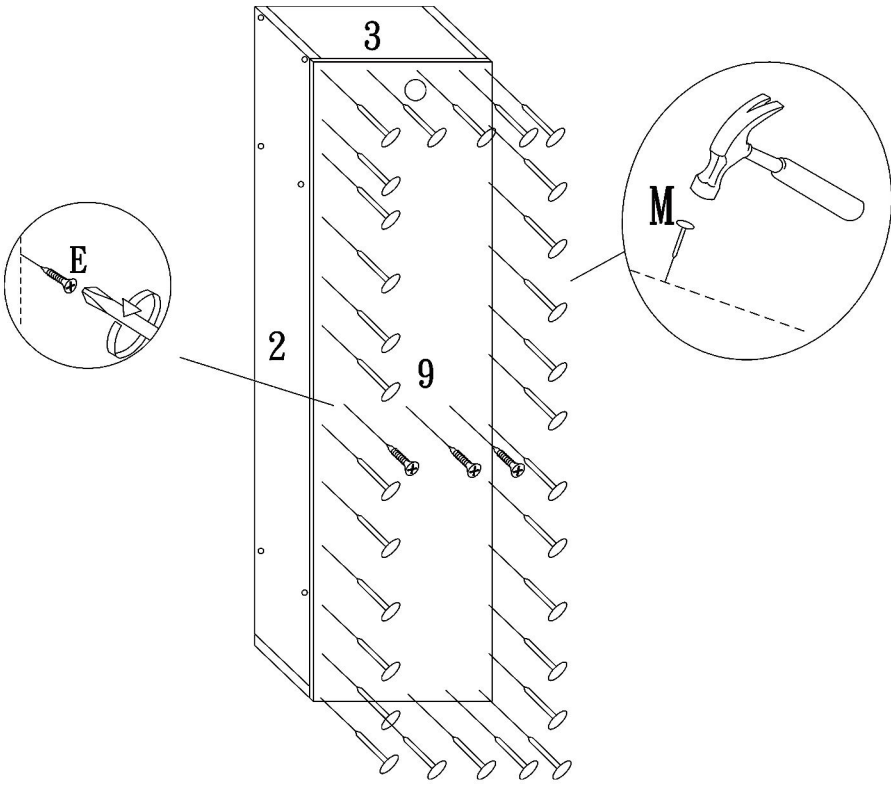
STEP 5	PARTS REQUIRED
	<p>9:BACK PANEL X1</p> <p>E:SCREWS X3 M:NAIL X30</p>

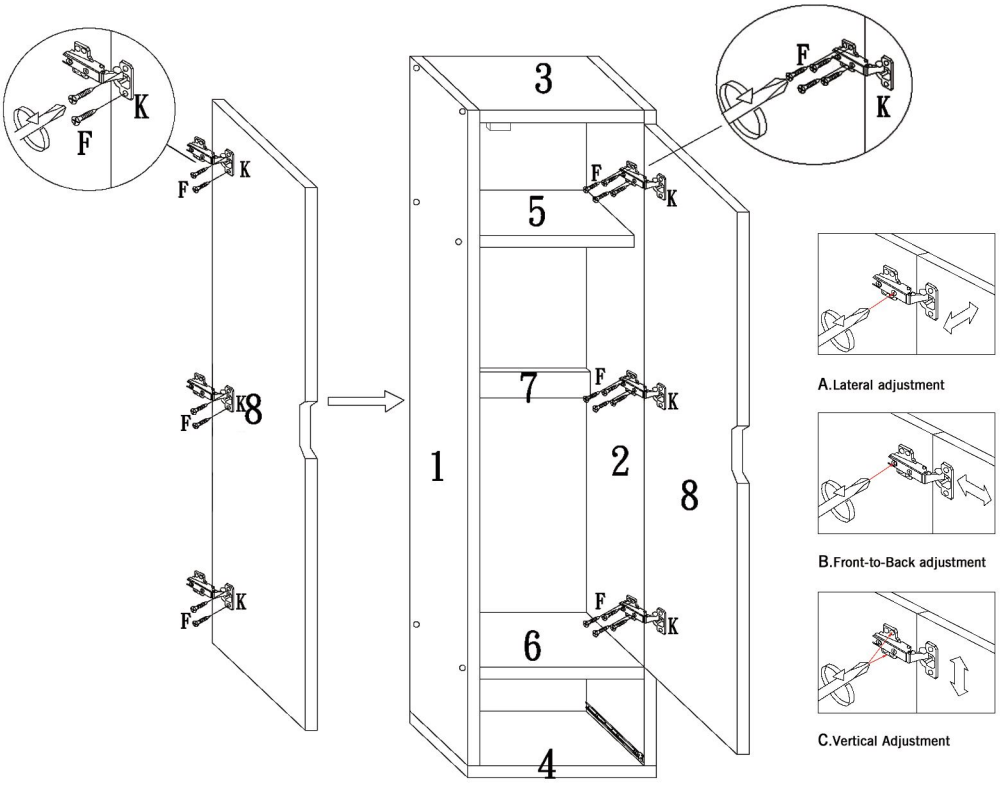
STEP 6	PARTS REQUIRED
	<p>8:DOOR PANEL X1</p> <p>F:SCREWS X18 K:HINGE X3</p>

STOCKHOLM 1 DOOR WARDROBE

ASSEMBLY INSTRUCTIONS

STEP 7	PARTS REQUIRED
	<p>E: SCREWS X20 O: LEG BRACKETS X4</p>

STEP 8	PARTS REQUIRED
	<p>N: LEG X4</p>

STOCKHOLM 1 DOOR WARDROBE

ASSEMBLY INSTRUCTIONS

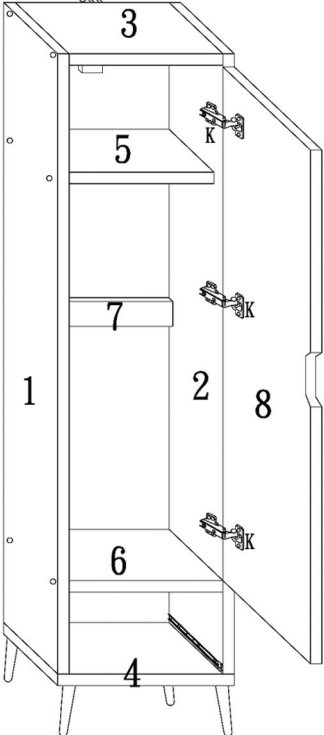
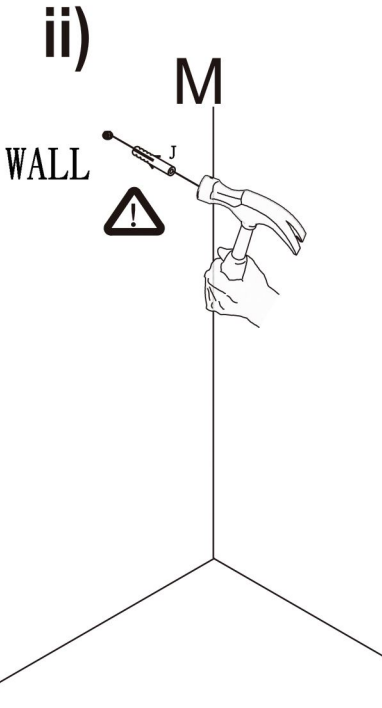
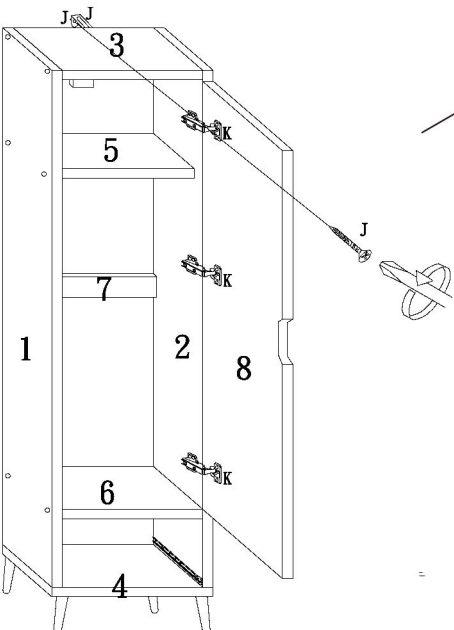
WALL STRAP	PARTS REQUIRED
<p>i)</p> <p>Remark </p>  <p>ii)</p>  <p>iii)</p> 	<p>J:WALL FIXING HARDWARE X1</p>

STOCKHOLM 1 DOOR WARDROBE ASSEMBLY INSTRUCTIONS

STEP 9	PARTS REQUIRED
	<p>F:SCREWS X4 H:BAR X1 I:FLANCE X2</p>

STEP 10	PARTS REQUIRED
	<p>G:STICKERS X12</p>

STOCKHOLM 1 DOOR WARDROBE ASSEMBLY INSTRUCTIONS

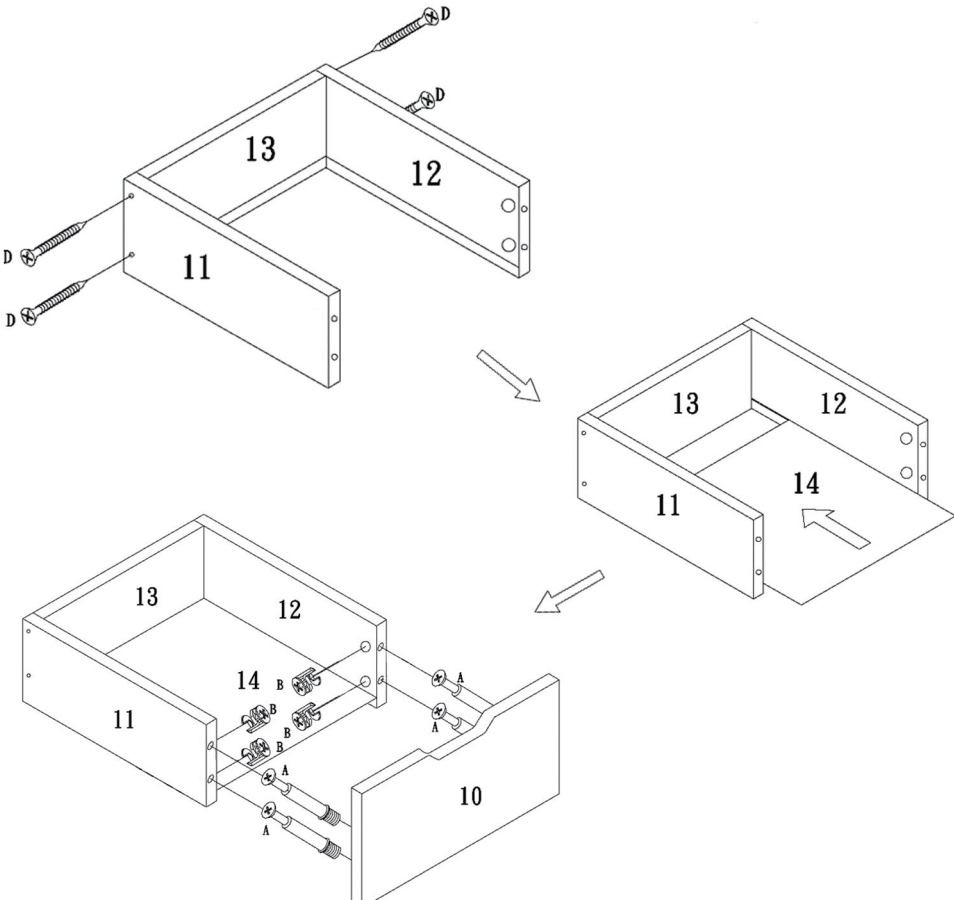
STEP 11	PARTS REQUIRED
	<p>10: DRAWER FRONT PANEL X1 11: DRAWER LEFT SIDE PANEL X1 12: DRAWER RIGHT SIDE PANEL X1 13: DRAWER BACK SIDE PANEL X1 14: BDRAWER BOTTOM PANEL X1</p> <p>A: CAM BOLT X4 B: CAM LOCK X4 D: SCREWS X4</p>

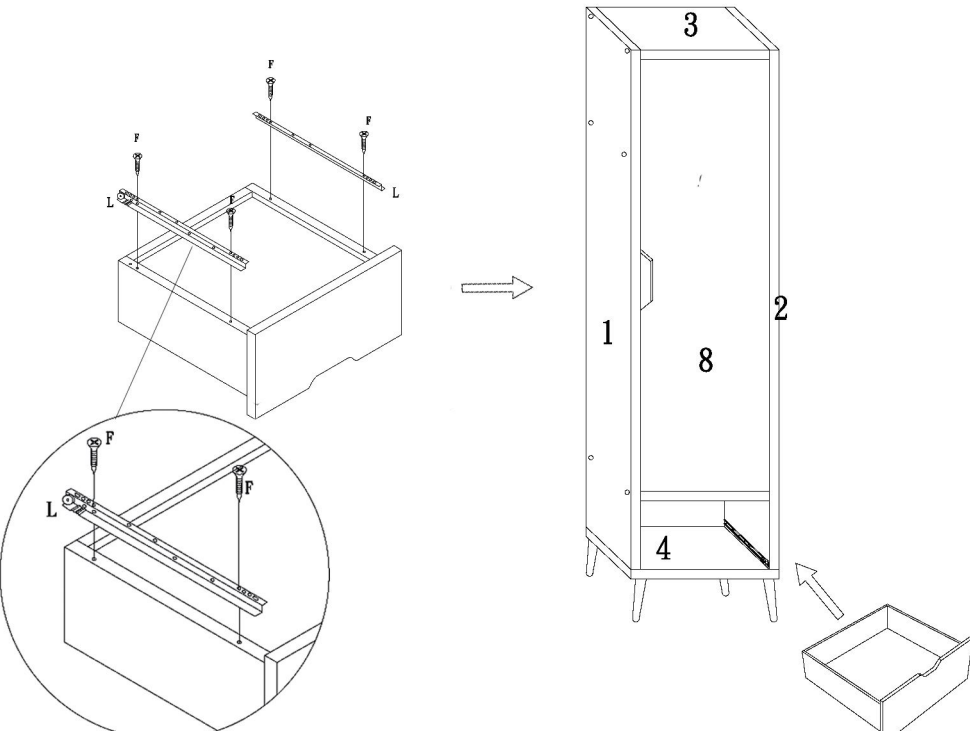
STEP 12	PARTS REQUIRED
	<p>F: SCREWS X4 L: DRAWER BASE RUNNER SETS X1</p>

STOCKHOLM 1 DOOR WARDROBE ASSEMBLY INSTRUCTIONS

Complete Assembly

Your **STOCKHOLM 1 DOOR WARDROBE** is now completely assembled.

Periodically check to ensure that the components are in their proper position, free from damage.

Also, make sure the connectors are tight and secure.

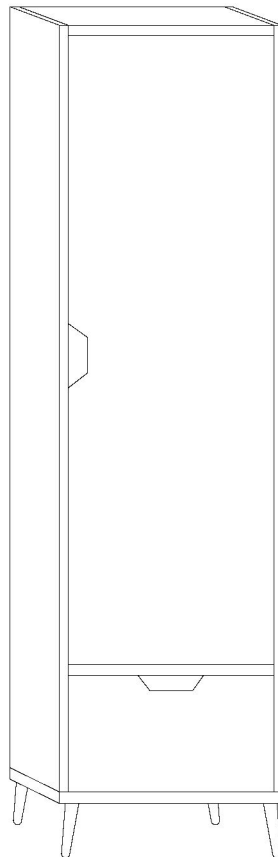

Retain these instructions for future reference.

