

# ASSEMBLY INSTRUCTION

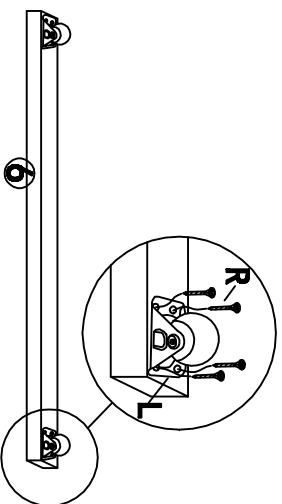

Step 3

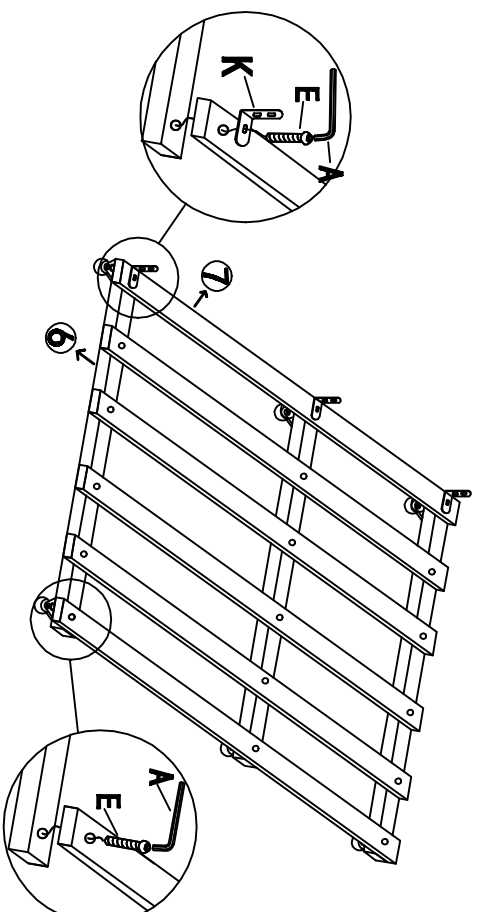

Step 4

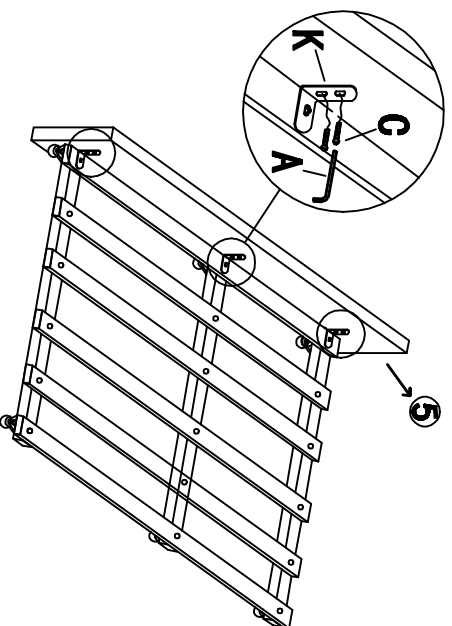

Step 5

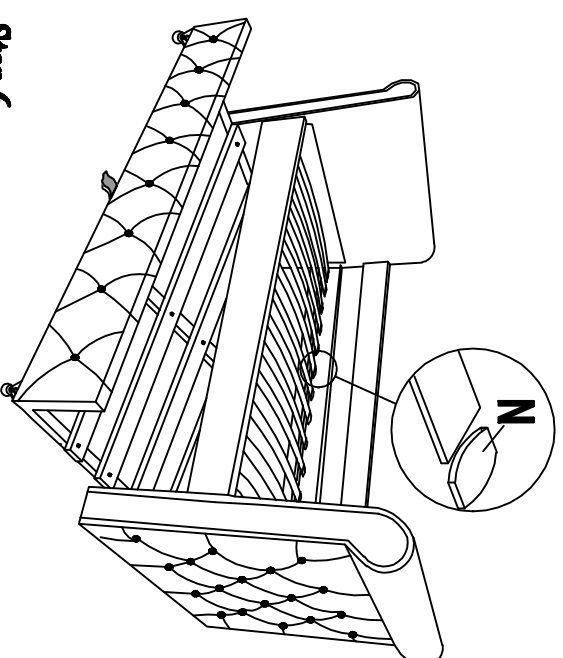

Step 6