

**IMPORTANT**

BECAUSE OF THE SIZE OF THIS UNIT, WE RECOMMEND THAT IT IS BUILT IN THE ROOM OF INTENDED USE AND ASSEMBLED BY 2 PEOPLE.

**BEFORE YOU START, HERE IS SOME HELPFUL ADVICE.**

1. The product you have purchased will give you many years of service if you follow the guidelines for its safe assembly, periodic maintenance and cleaning.
2. Do not use any tools other than those indicated. Use of a power tool to assemble the product will invalidate any claim and could make this product unsafe.
3. Do not discard any packaging until you have checked that you have all the parts and hardware. Discard any excess fittings and keep all fittings out of reach of children.
4. Assemble this product on a clean flat surface to avoid any scratching.
5. Assemble all parts loosely before tightening any bolts. Ensure bolts are fully tightened but not forced as over-tightening may damage this product and/or fittings.

**CARING FOR YOUR LIMELIGHT BED**

1. When moving your fully assembled bed, you must first remove the mattress and lift the frame into position. Take care when lifting to always have two people handling the bed. PLEASE DO NOT DRAG THE BED as this may cause misalignment to the bedbase, making it unsafe.
2. It is advisable to use approved leather cleaning products when cleaning the upholstered panels as certain chemical based cleaners could have an adverse effect on the faux leather finish.
3. Depending on usage, it may be necessary to tighten up the fittings from time to time.

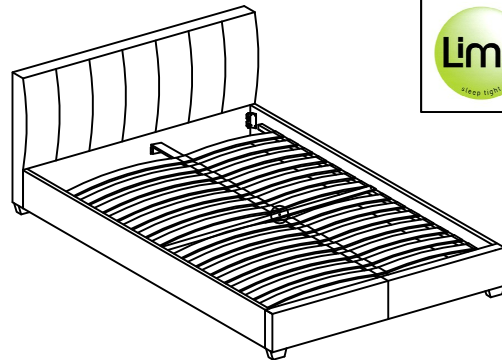
**PROBLEM?**

All Limelight beds are produced to the highest standards and are packed to avoid damages in transit. Should you find that your new bed does not meet your satisfaction, please contact us.

If you encounter any difficulty with the assembly of your bed, PLEASE DO NOT TROUBLE your retailer but do contact our **CUSTOMER SERVICES DEPARTMENT** at the following hours:

**9.00AM TO 5.00PM on MONDAY TO THURSDAY,  
9.00AM TO NOON on FRIDAY.**

TEL: **01455 850150**

FAX: **01455 845149**

EMAIL : [info@limelightbeds.co.uk](mailto:info@limelightbeds.co.uk)

ADDRESS:

**Limelight Beds Ltd  
Orbital House, Arthur Street  
Barwell, Leicestershire, LE9 8GZ**



Please have the **PRODUCT NAME** and **PART NUMBER** ready for our staff.

See our product range online at [www.limelightbeds.co.uk](http://www.limelightbeds.co.uk)

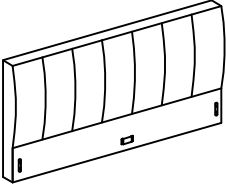
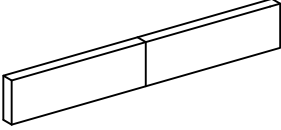
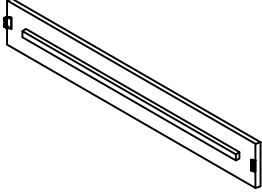
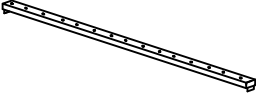

**IMPORTANT NOTICE**

**Should you need to return unassembled product . Please repack in original packaging .**

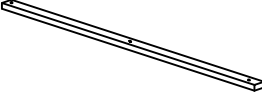
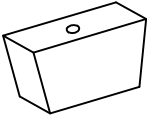
**PARTS LIST**

<p><b>(A) HEADBOARD (1 PC)</b></p> 	<p><b>(B) FOOTBOARD (1 PC)</b></p> 	<p><b>(C) SIDE RAIL (2 PCS)</b></p> 	<p><b>(D) CENTRAL RAIL (1 PC)</b></p> 
<p><b>(E) SUPPORT LEG (3 PCS)</b></p> 	<p><b>(F) SPRUNG SLAT (26 PCS)</b></p> 	<p><b>(G) STIFFENER SLAT (1 PC) (3 HOLES)</b></p> 	<p><b>(H) WOODEN LEGS (4 PCS)</b></p> 

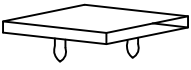
**HARDWARE LIST**

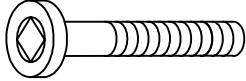
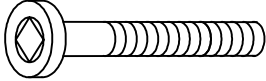
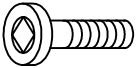
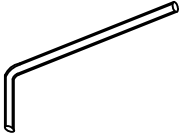
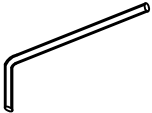
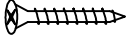
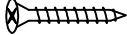
<p><b>(1) SLAT MIDDLE HOLDER (13 PCS)</b></p> 	<p><b>(2) SLAT END HOLDER (26 PCS)</b></p> 	<p><b>(3) JCBC M6 X 40mm(3 PCS)</b></p> 	<p><b>(4) JCBC M6 X 50mm(4 PCS)</b></p> 	
<p><b>(5) JCBC M8 x 16mm (8pcs) (PRE-ATTACHED)</b></p> 	<p><b>(6) ALLEN KEY M4 X 100mm (1 PC)</b></p> 	<p><b>(7) ALLEN KEY M5 X 70mm (1 PC)</b></p> 	<p><b>(8) CSK M4 x 25mm (2 PCS)</b></p> 	<p><b>(9) CSK M4 x 32mm (3 PCS)</b></p> 

Step 1 : Tighten the wooden leg (H) to the headboard (A) and footboard (B).

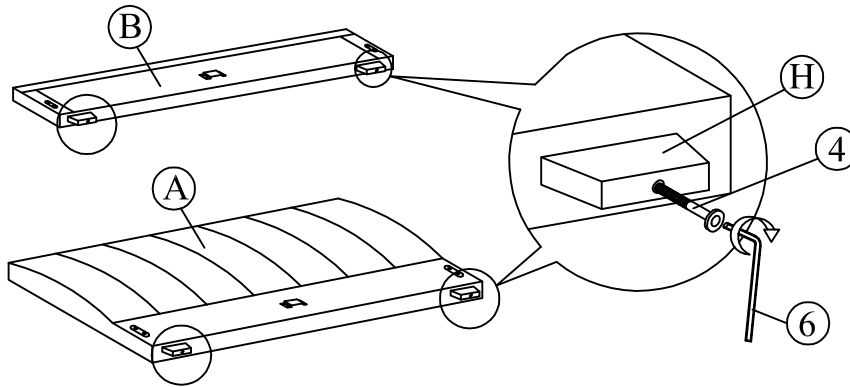

Step 2: Attach Side Rail (C) to Headboard (A) and Footboard (B) by pushing the bracket down to fit it.

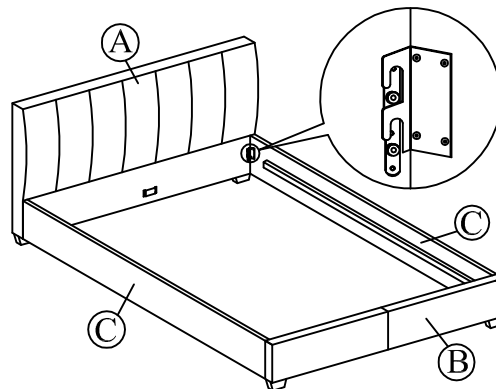

Step 3: Attach the support legs (E) to the center rail (D) of the bed as shown.

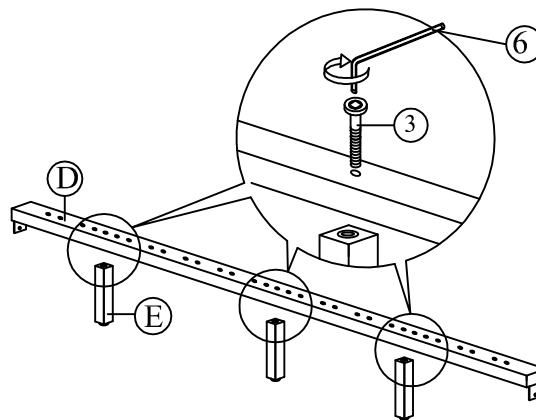

Step 4: Slide the center rail (D) to the headboard (A) and footboard (B). Tighten screws (8) using screw driver (not included) to the headboard (A) and footboard (B).

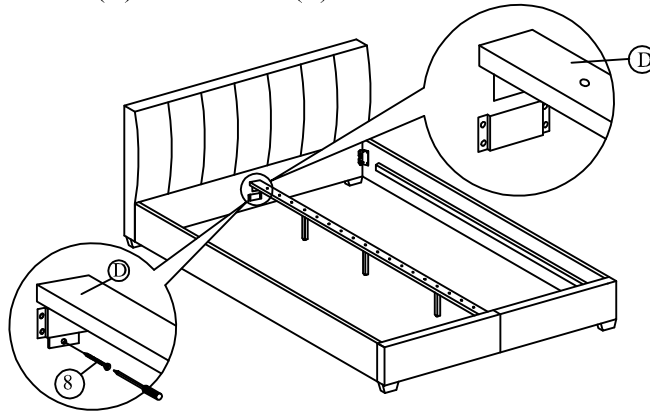

Step 5: Affix the Stiffener Slat (G) to the side rail support wood and the center rail (D). Tighten all the 4 corner, follow by assembly of the slat holders with LVL slats as shown.

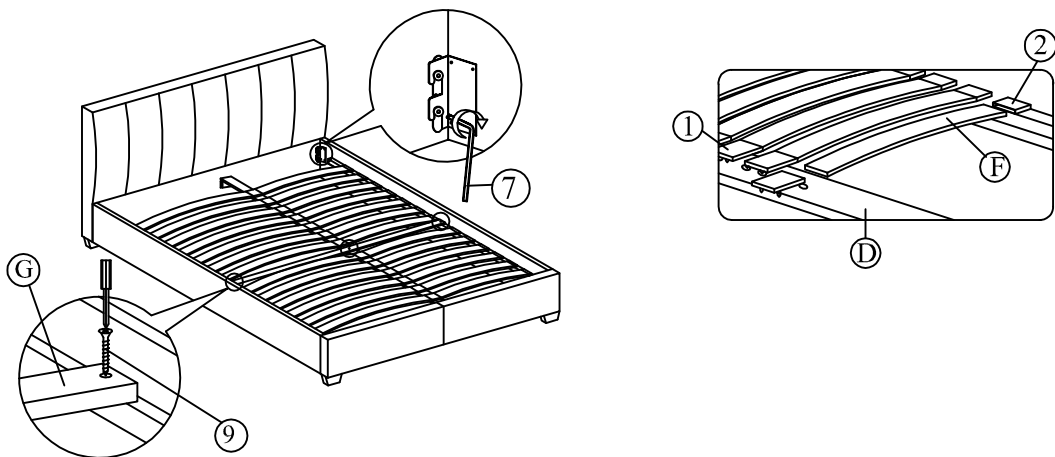

END OF INSTRUCTION