



Birlea

Suppliers of inspiration

Vendor: S000013

PO: F02667



ASSEMBLY INSTRUCTIONS MARLOW 6' BED

IMPORTANT : READ THESE INSTRUCTIONS CAREFULLY BEFORE ASSEMBLING OR USING YOUR MARLOW 6' BED FRAME

PLEASE KEEP THESE INSTRUCTIONS FOR FUTURE REFERENCE.

HEALTH & SAFETY:

DO NOT jump on this bed frame.

DO NOT use this bed frame if any parts are missing, damaged or worn.

DO NOT use this bed frame unless all fixings are secured.

Please keep small parts out of reach of children.

Always use on a level, even surface.

WARNING : If this bed is placed on a non- carpeted floor you must place some protection under all legs to stop the bed frame from moving. if this is not adhered to there is no guarantee if the bed frame collapses.

CARE & MAINTENANCE:

Assembly in the room use.

Periodically check all screw & fixings to ensure they are secure.

DO NOT push the bed frame as this will damage the legs.

Always lift the bed with two people to reposition.

Keep any sharp objects away from the frame.

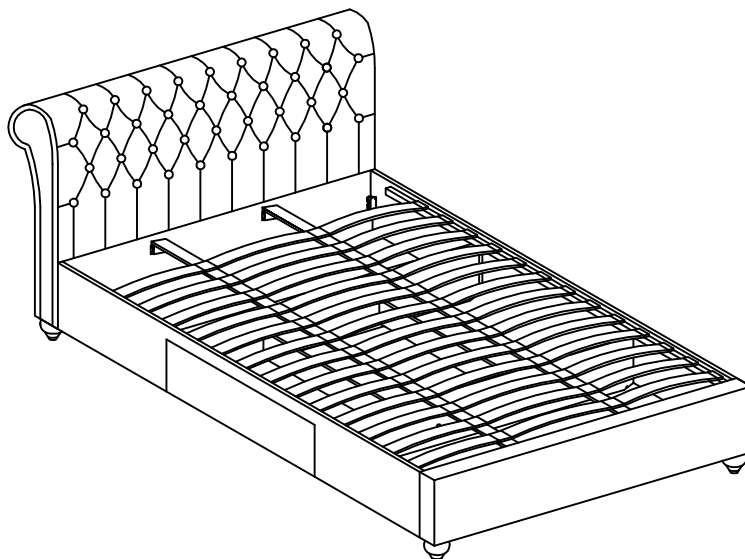











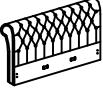



Birlea

Suppliers of inspiration

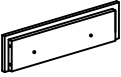
www.birlea.com

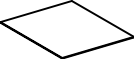
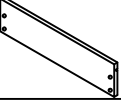













Page 1 of 6

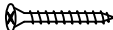
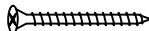

Parts List			
Parts	Description	Box	Qty
1	Headend 	1	1
2	Footend 	2	1
3	Side Rail 	2	2
4	Slat 	2	42
5	Centre Rail 	2	2
6	Legs 	2	2
7	Drawer Runner Pack 1 	3	4
8	Drawer Runner Pack 2 	3	4
9	Drawer Front 	2	2
10	Drawer Back 	3	2
11	Drawer Base 	3	2
12	Drawer Side 	3	4
13	Drawer Support 	3	4
14	Drawer Holder Side Panel 	3	2
15	Drawer Holder Mid Panel 	3	2
16	Drawer Base Support Panel 	3	2

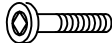



Hardware List			
Parts	Description	Box	Qty
A	Plastic Dowel (8 x 25) 	2	20
B	M6 x 40 mm JCBC W 	2	8
C	Mini Fix Bolt 	2	8
D	Mini fix Housing 	2	8
E	Mini Fix Cap 	2	8
F	Power Nail 6/8 	2	32
G	White Nail 	2	10
H	M3.5 x 16 mm CSK 	2	24+1
I	M4 x 25mm CSK 	2	4
J	M4 x 32 mm CSK 	2	8
K	M4 x 50 mm CSK 	2	16
L	Allen Key 65 mm 	2	1
M	M6 x 30 mm JCBC 	2	8
N	M6 Flat Washer 	2	8
O	Double Slat Cap 	2	28
P	Single Slat Cap 	2	28

*You will need a small mallet and screwdriver (not provided)

* There is one CSK screw 16mm as spares.





Step 1 : Join together the drawer front (9), drawer back (10) and drawer side (12) using hardware part K and screwdriver (not provided). Repeat for the remaining drawer.

DO NOT use any power tools as this may damage the frame and will invalidate any claim.

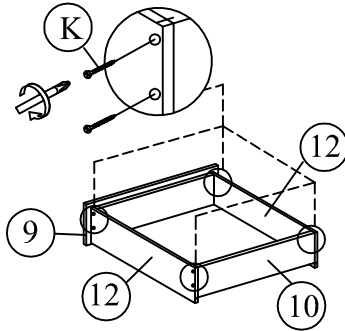

Step 2 : Slide the drawer base (11) into position on all both drawer . Secure with hardware part F and small mallet (not provided).

DO NOT use any power tools as this may damage the frame and will invalidate any claim.

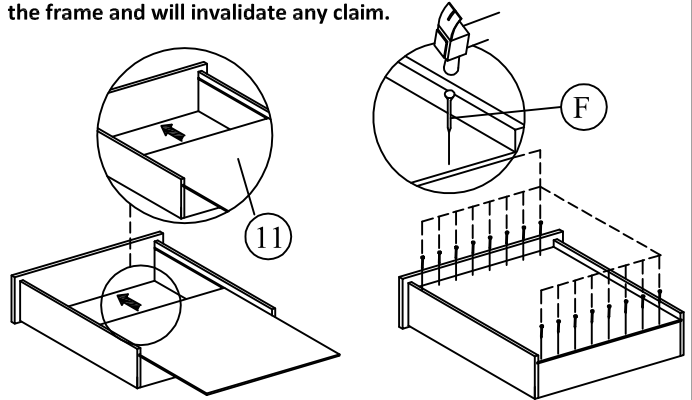

Step 3 : Secure the drawer support (13) using hardware part J and screwdriver(not provided).

DO NOT use any power tools as this may damage the frame and will invalidate any claim.

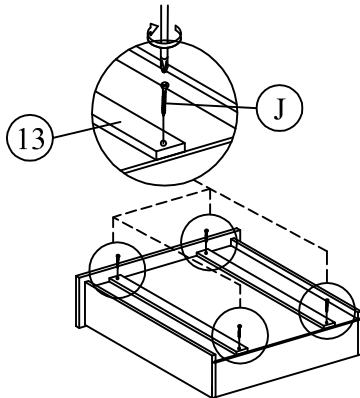

Step 4 : Attach the drawer runner from pack 1 (7) using hardware part H and screwdriver(not provided).

DO NOT use any power tools as this may damage the frame and will invalidate any claim.

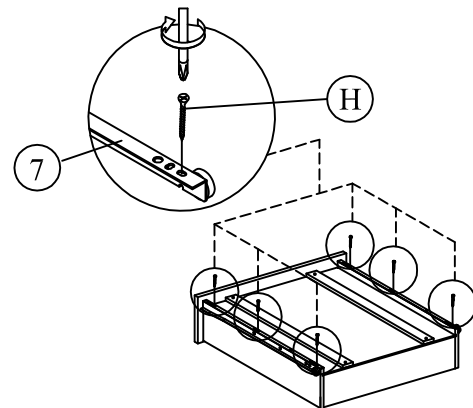

Step 5: Attach the drawer runners (8) to the drawer holder side panels (14) using hardware part H and a screwdriver (not provided).

DO NOT use any power tools as this may damage the frame and will invalidate any claim.

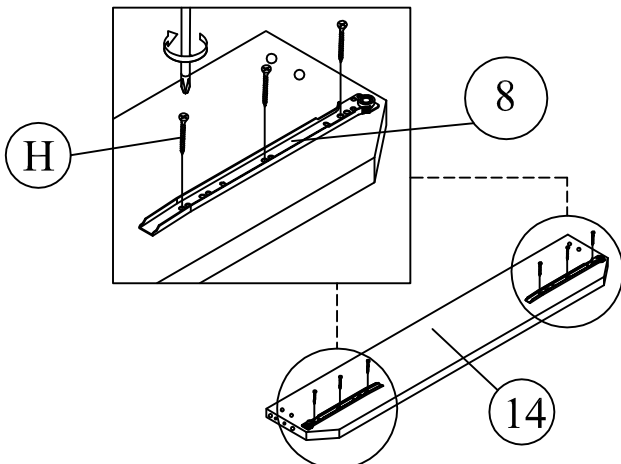

Step 6: Insert hardware parts A and G to the drawer holder side panels (14) using a small mallet (not provided).

DO NOT use any power tools as this may damage the frame and will invalidate any claim.

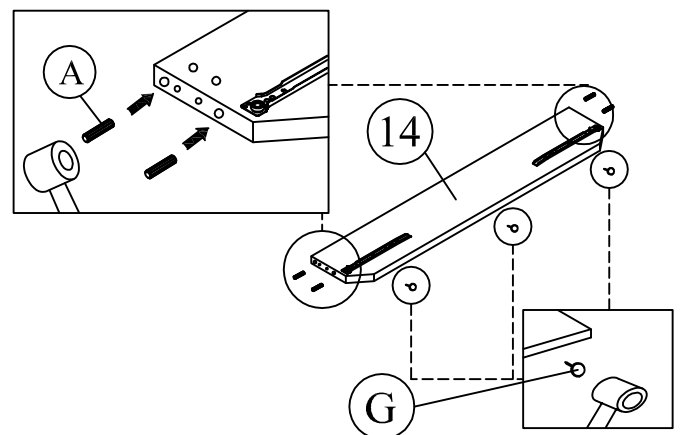



Step 7: Insert hardware parts A and G to the drawer holder mid panels (15) using a small mallet (not provided).

DO NOT use any power tools as this may damage the frame and will invalidate any claim.

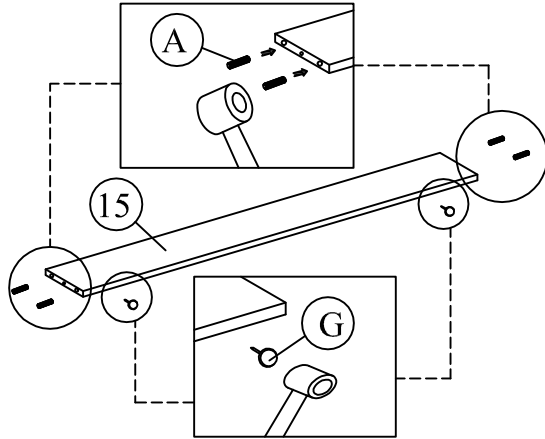

Step 8: Insert hardware parts A to the drawer base support panels (16) using a small mallet (not provided).

DO NOT use any power tools as this may damage the frame and will invalidate any claim.

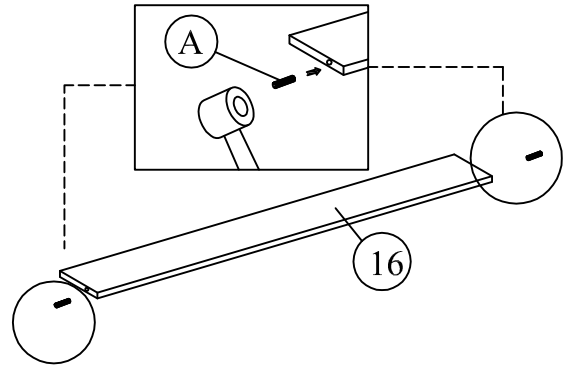

Step 9: Secure the drawer holder panels & drawer holder mid panels & drawer base support panels together as shown using hardware parts B and L. **DO NOT use any power tools as this may damage the frame and will invalidate any claim.**

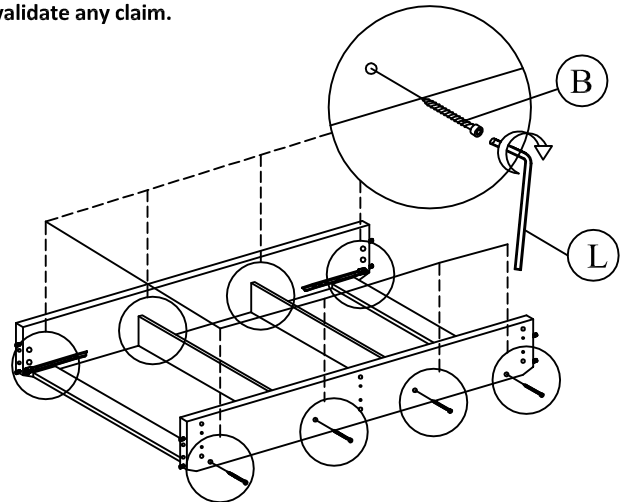
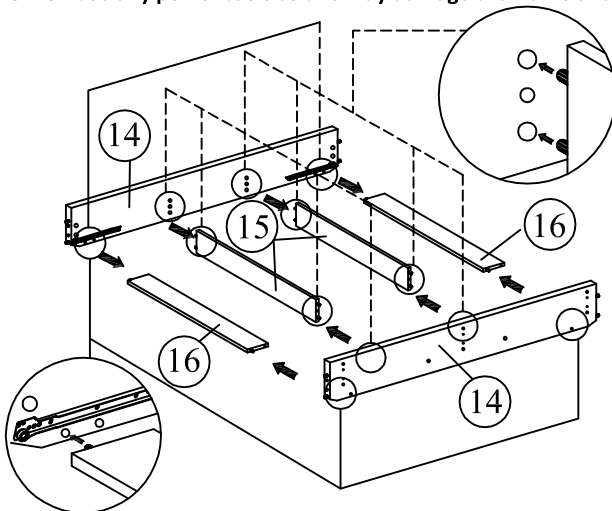

Step 10: Insert hardware part C to the side rails (3) using a screwdriver (not provided).

DO NOT use any power tools as this may damage the frame and will invalidate any claim.

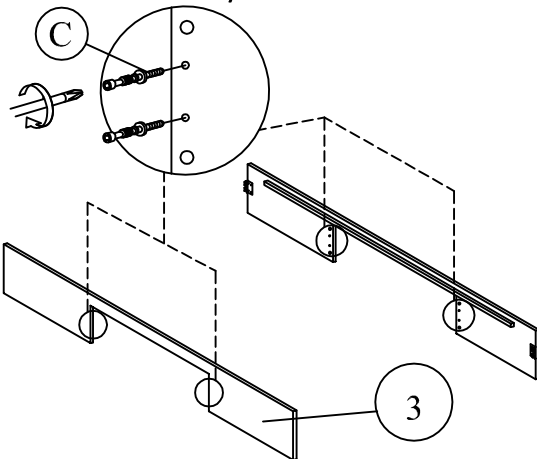

Step 11: Attach the assembled drawer holder frame to the side rails (3).

DO NOT use any power tools as this may damage the frame and will invalidate any claim.

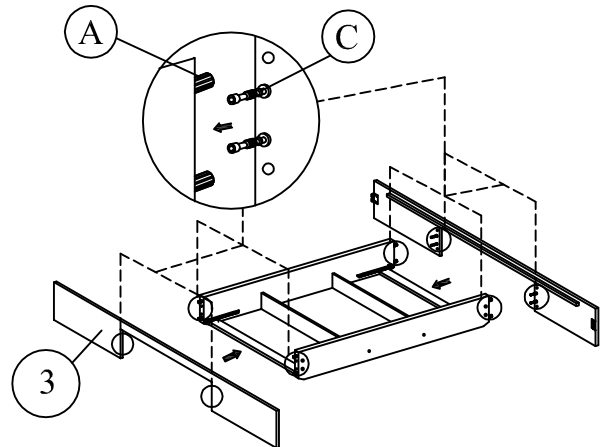



Birlea

Suppliers of inspiration

Vendor: S000013



Step 12: Using hardware parts D , L and M then insert hardware part E as shown.

DO NOT use any power tools as this may damage the frame and will invalidate any claim.

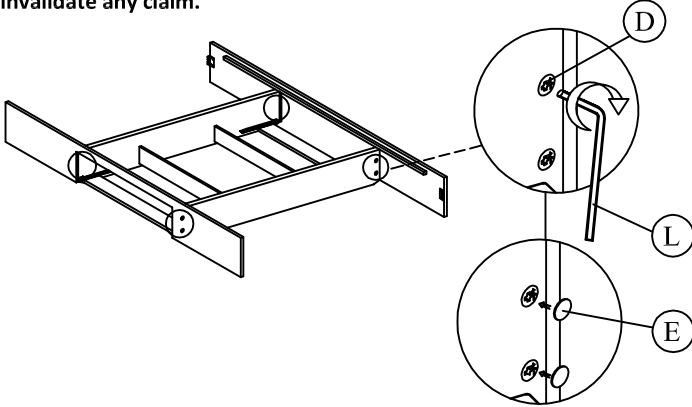

Step 13: Attach the legs (6) to the headend (1) and footend (2).

DO NOT use any power tools as this may damage the frame and will invalidate any claim.

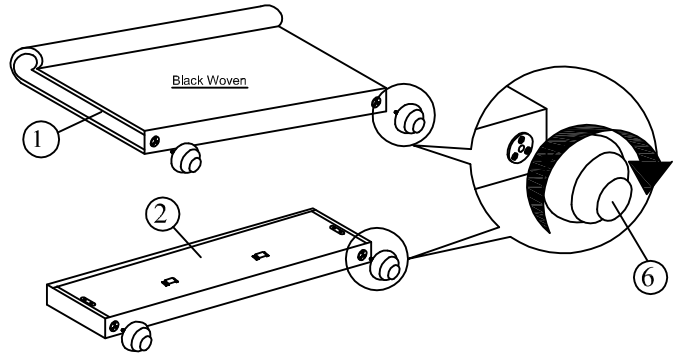

Step 14: Secure the frame using hardware parts L ,M and N.

DO NOT use any power tools as this may damage the frame and will invalidate any claim.

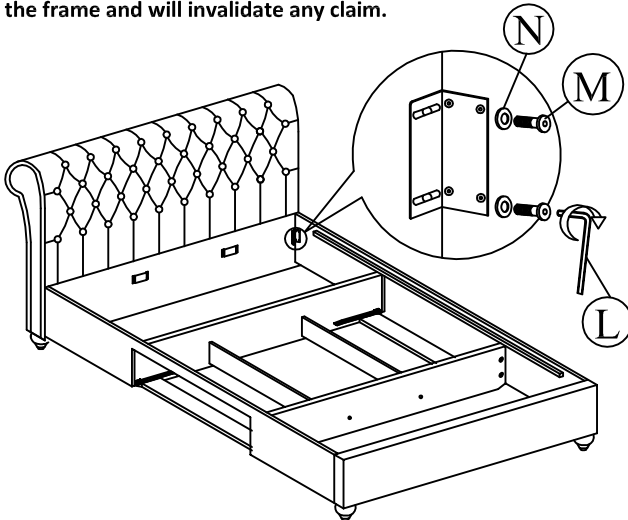

Step 15 : Attach the centre rail (5) to the headend (1) and footend (2) using hardware part I and a screwdriver(not provided)

DO NOT use any power tools as this may damage the frame and will invalidate any claim.

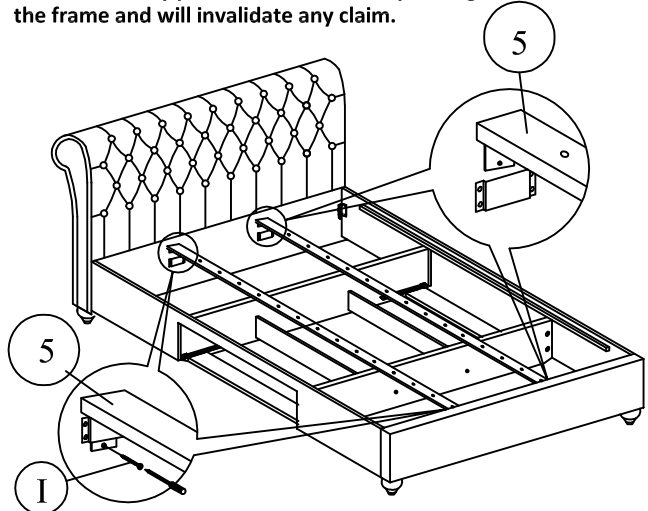

Step 16: Attach the slats (4) to the side rails (3) and centre rail (5) using hardware parts O and P. Insert the assembled drawers to the bed frame.

DO NOT use any power tools as this may damage the frame and will invalidate any claim.

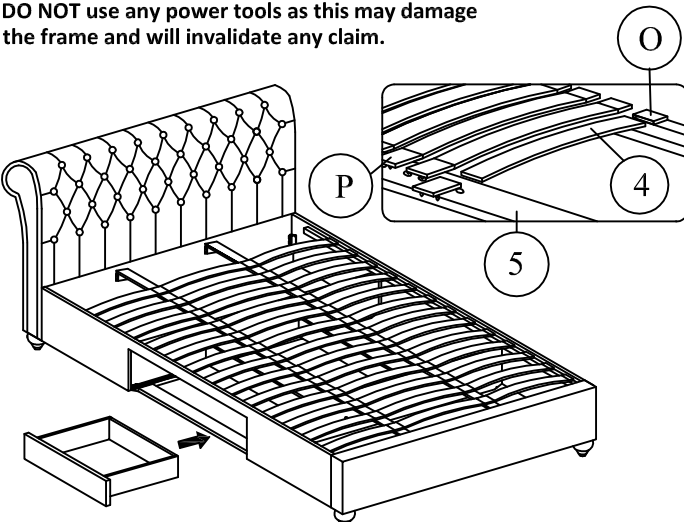

Additional Information:

- For complete product information, images and dimension diagrams please visit the website www.birlea.com
- If you have any issues with your item please contact the retailer directly you purchased it from who will be able to resolve any issues with Birlea.
- Why don't you send us photos of your assembled furniture to info@birlea.com to be shared in our #birleahome feature on Instagram.



Birlea

Suppliers of inspiration

www.birlea.com

Page 6 of 6